



ClearFuels Technology Inc.

Pacific Coast Electrical Association

Hawaii Conference

Grand Wailea Resort Maui, Hawaii.

September 7,2007

**Production of Fuels Energy and Food
from Biomass**

Robert Shleser - CTO

Enabling Highly Efficient Low Cost Sustainable Energy Production



ClearFuels Technology Inc

BIOMASS ENERGY OPPORTUNITIES

GOALS

Review the biomass energy, liquid fuels situation

Discuss potential opportunities

Identify synergies and opportunities

Understand and preserve our options

CORN-ETHANOL ISSUES



NOTHING NEW ABOUT CORN- ETHANOL



Ethanol as fuel is not a new idea

*New York Times (1837-Current file); Sep 20, 1925; ProQuest Historical Newspaper
pg. 24*

FORD PREDICTS FUEL FROM VEGETATION

***He Says Electricity Will Heat
Cities in the Future—Tells of
Testing a New Flour.***

BOSTON, Sept. 19 (AP).—The time is coming when Americans will grow their own fuel and American cities will be heated by electricity, Henry Ford is quoted as saying during his stay at his Wayside Inn in Sudbury, in an interview published by The Christian Science Monitor today.

"The fuel of the future," he said, "is going to come from fruit like that sumach out by the road, or from apples, weeds, sawdust—almost anything. There is fuel in every bit of vegetable matter that can be fermented. There's enough alcohol in one year's yield of an acre of potatoes to drive the machinery necessary to cultivate the field for a hundred years.

NY Times- Sept 20, 1925



Photo, taken in April 1933, shows a Lincoln Nebraska gas station of the Earl Coryell Co. selling "Corn Alcohol Gasoline."

Corn Cellulosic Ethanol



grain



Traditional Corn-Ethanol Plant



stover



Stover Gasification Plant

CORN- (not the total answer)

In a document “The Case for Ethanol” Anna Halpern-Lande states:

- Using cellulosic waste will be critical if ethanol markets are to mature.
- The energy bill creates a nationally mandated threshold to 7.5 billion gallons,
- We simply will not have enough corn.
- Our capacity to produce corn-based ethanol will max out at around 10 billion gallons,
- Corn stover- the stalk and leaves from corn alone would add 7 to 12 billion gallons of ethanol capacity.

Cellulosic Ethanol Technology

BIOMASS – ETHANOL BACKGROUND

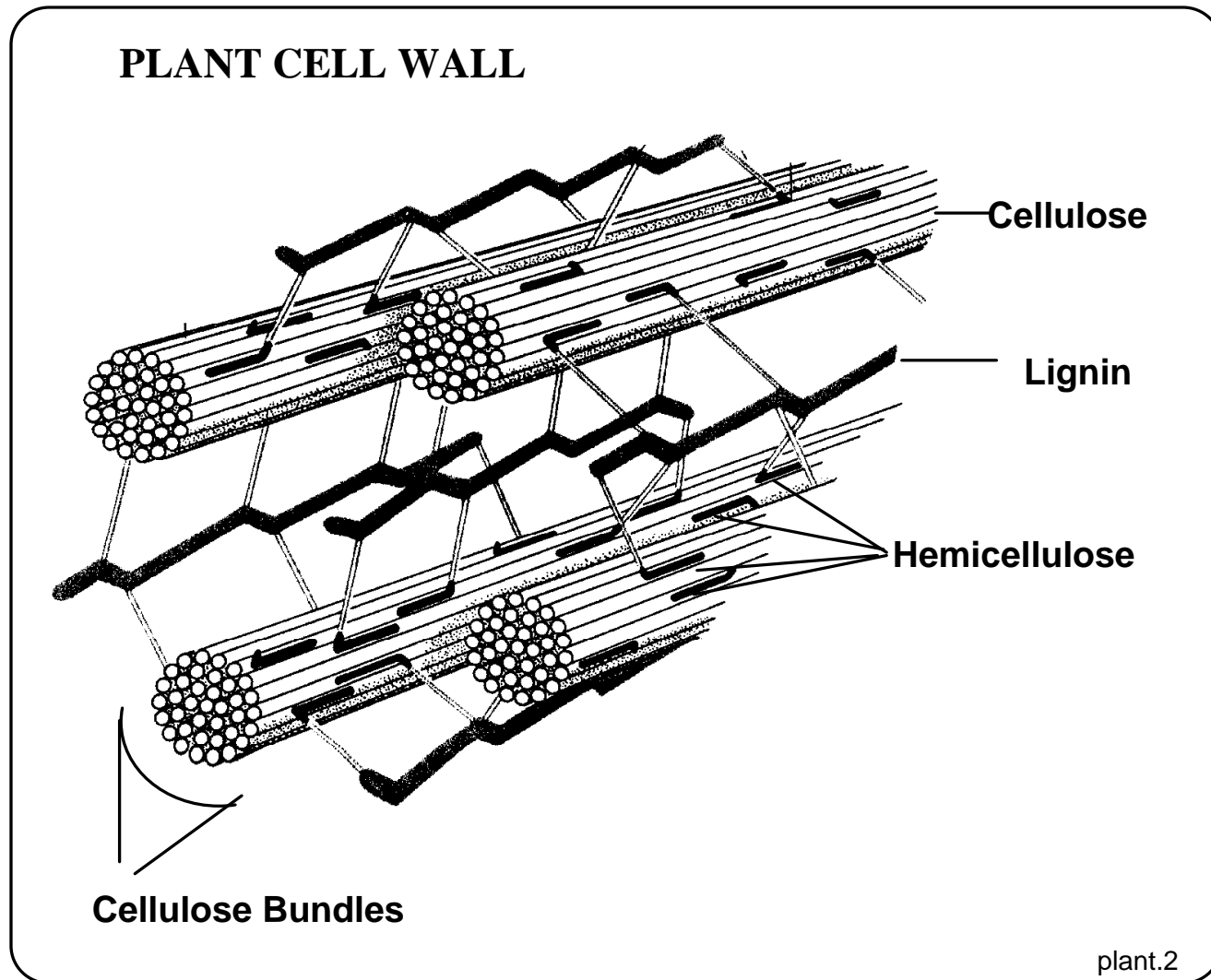

Lignocellulosic Biomass



Corn Stover



Bagasse



Hardwood

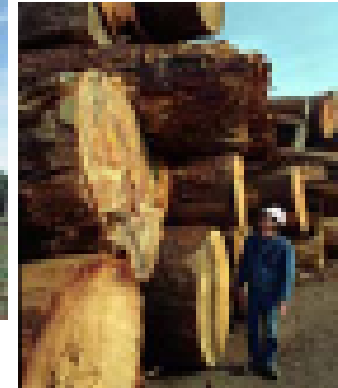

Softwood

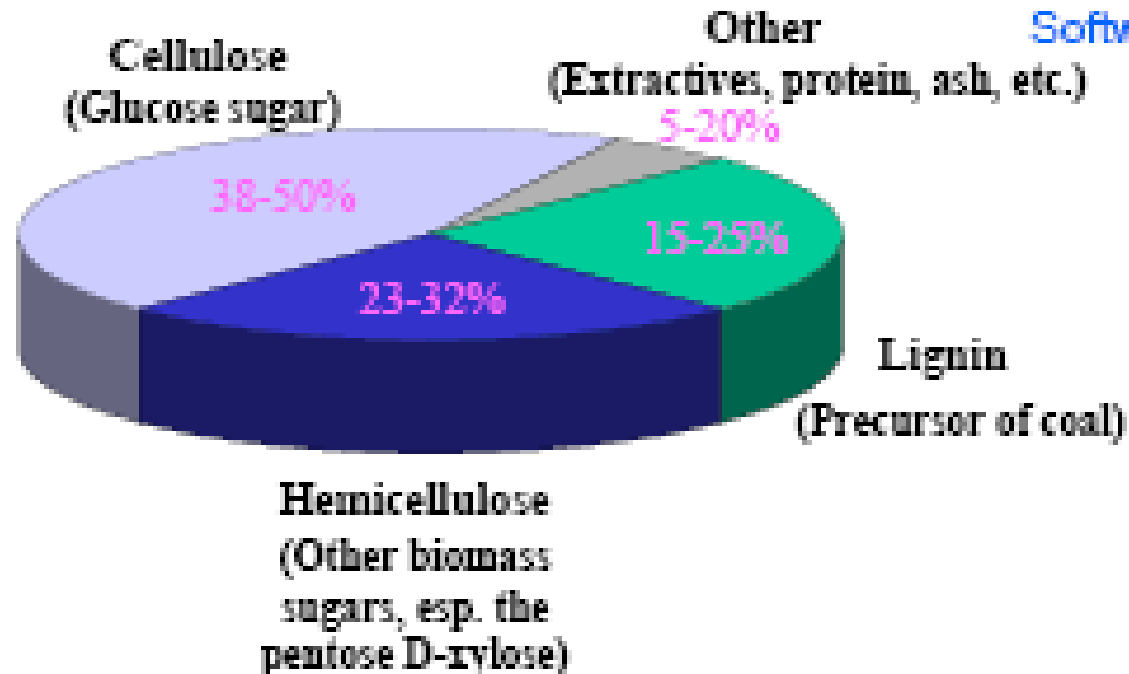

Sugar Release & Fermentation

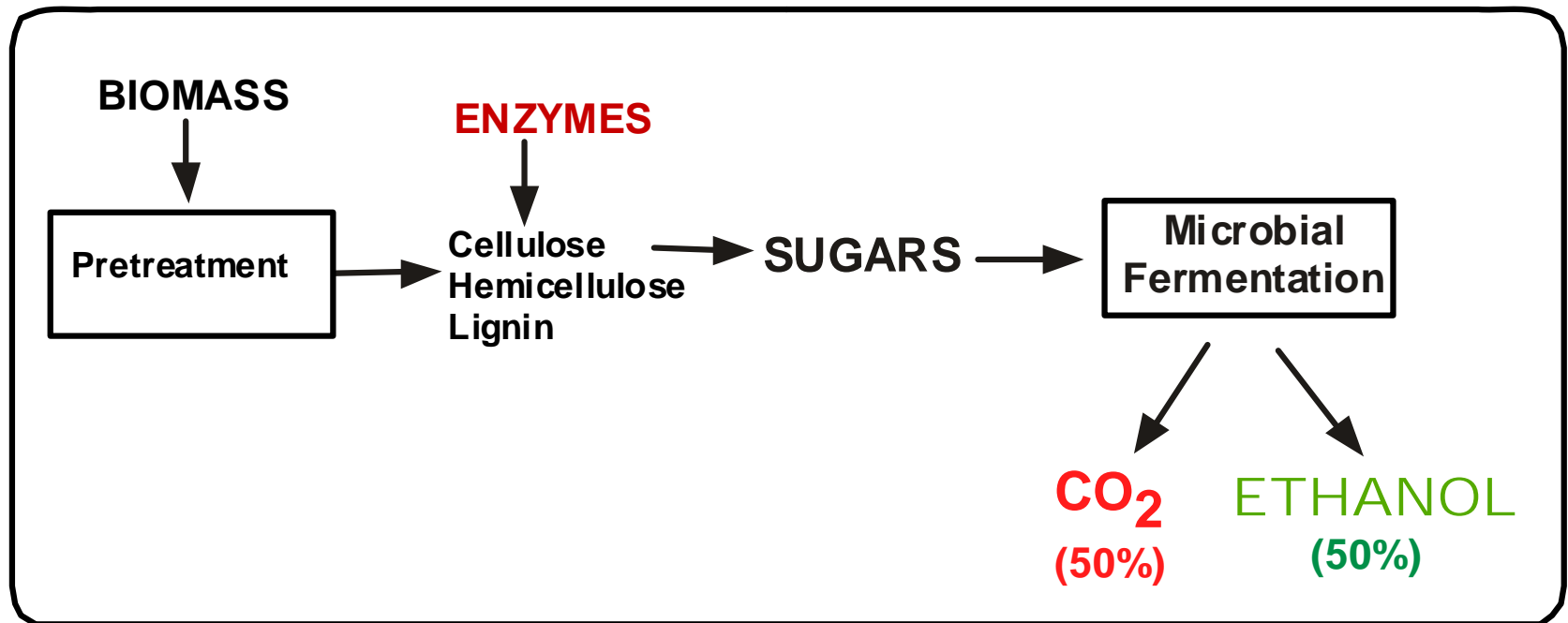



ClearFuels - Pearson Process Technology

GASIFICATION-CATALYTIC CONVERSION PROCESS

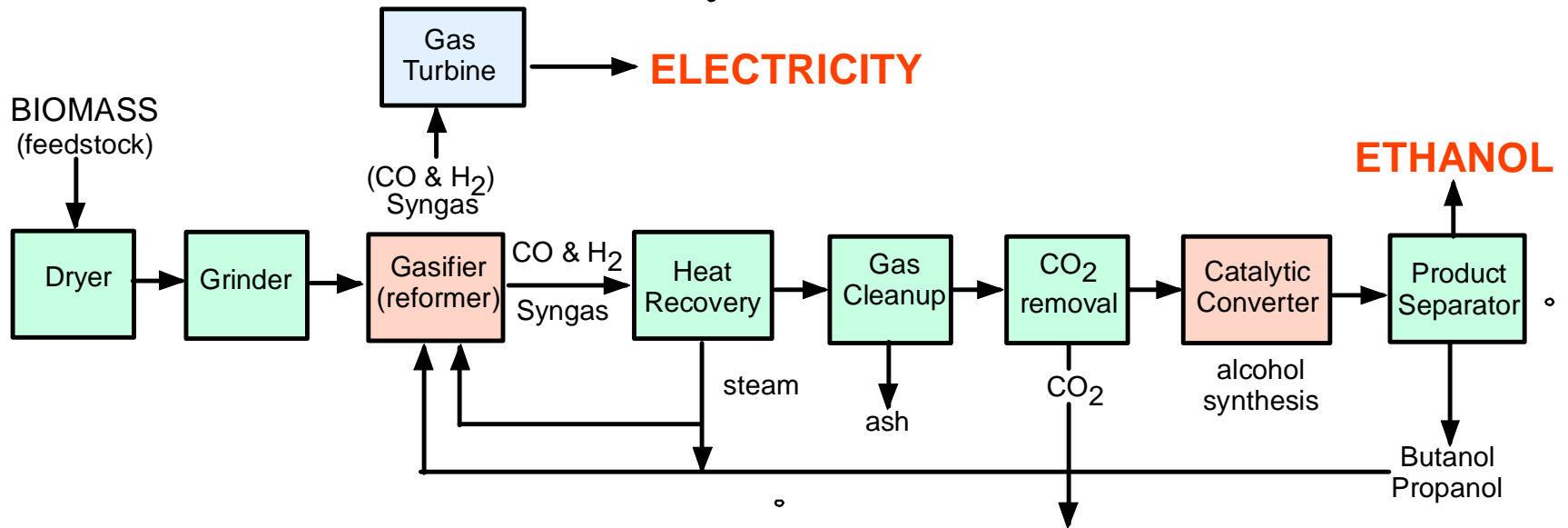

Pearson Biomass

BIOMASS GASIFICATION OPTIONS

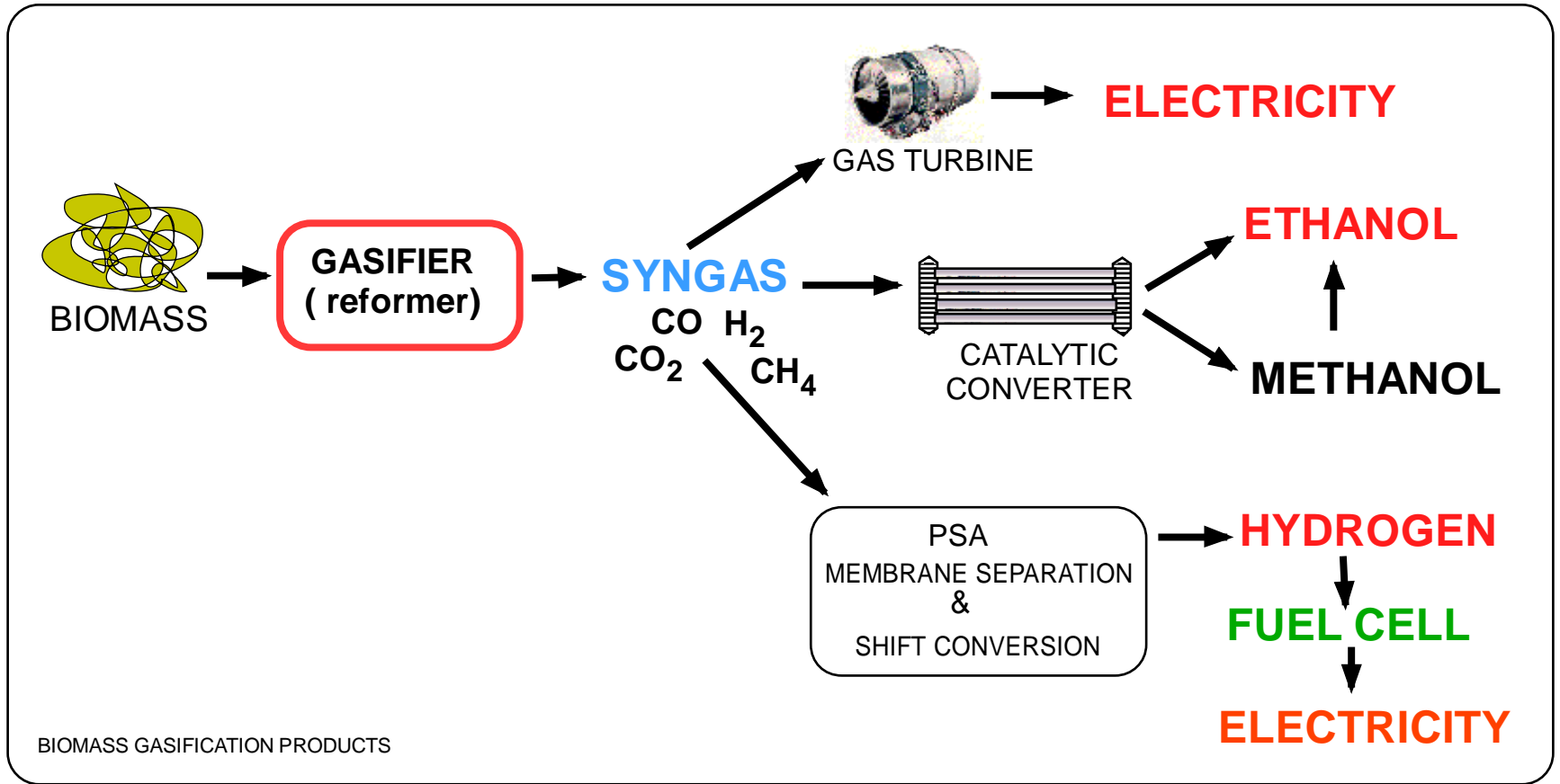

Cellulosic Ethanol Technologies

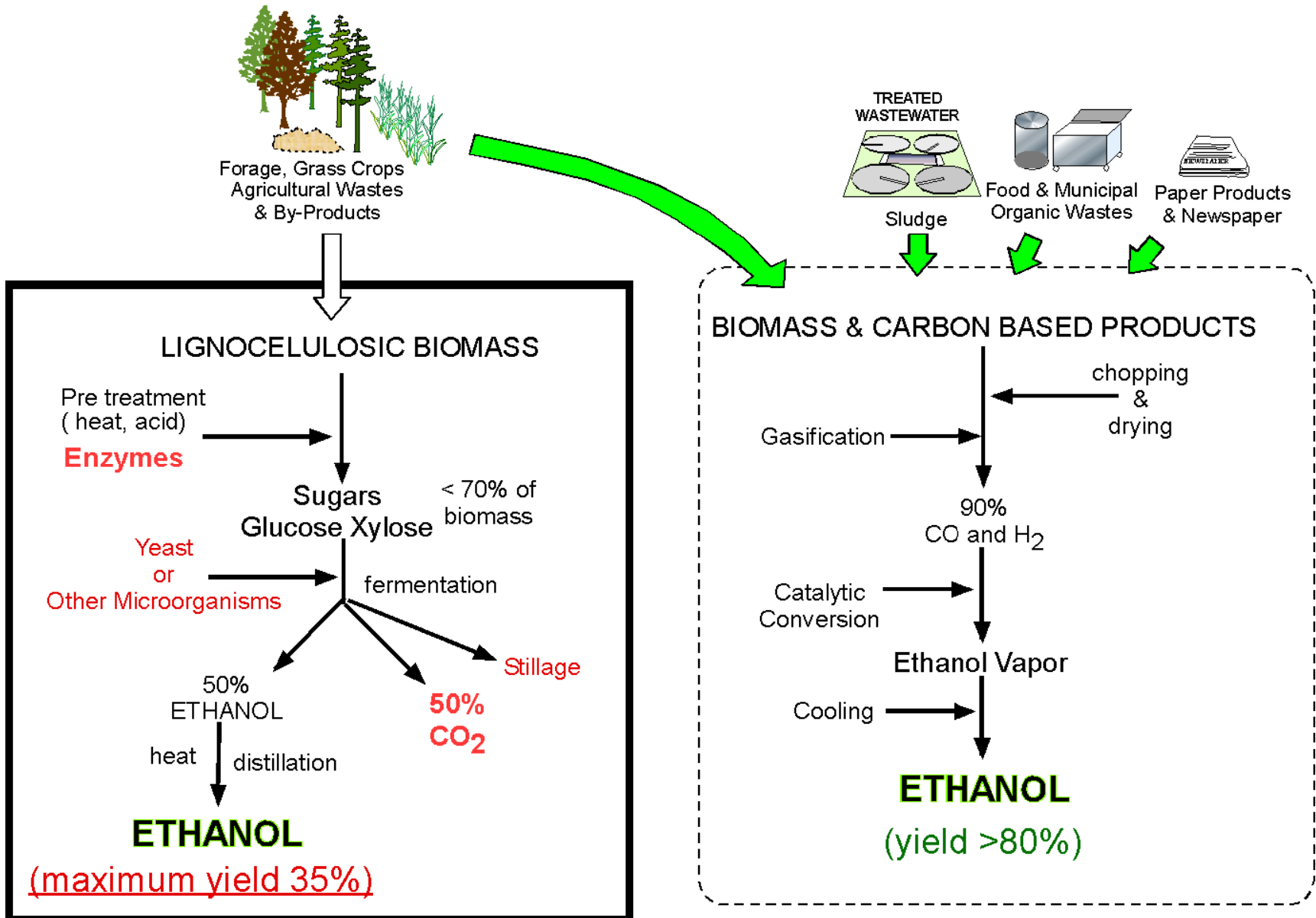

Sugar Crop Biomass

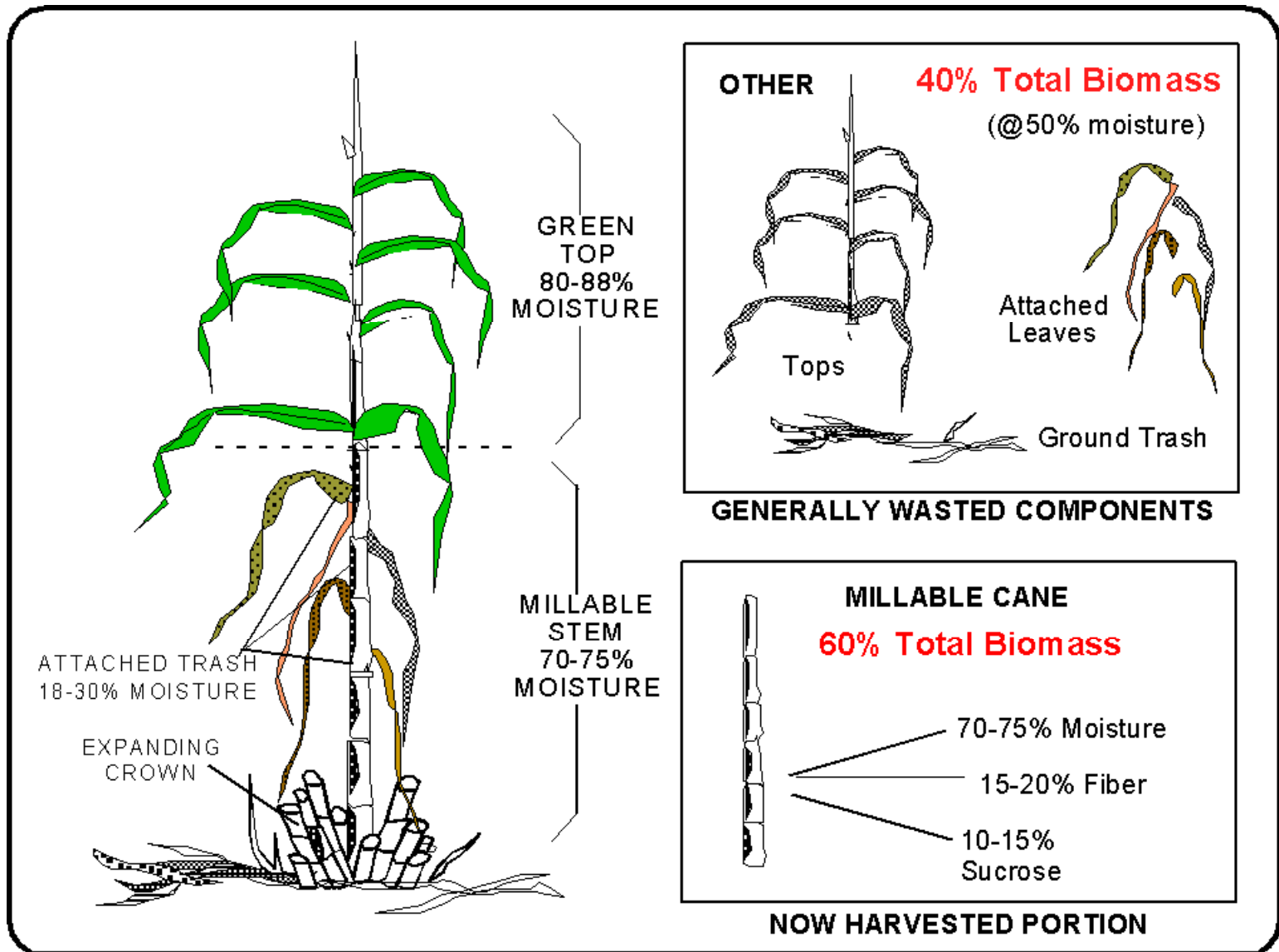

Integrated Sugar Crop Ethanol Production

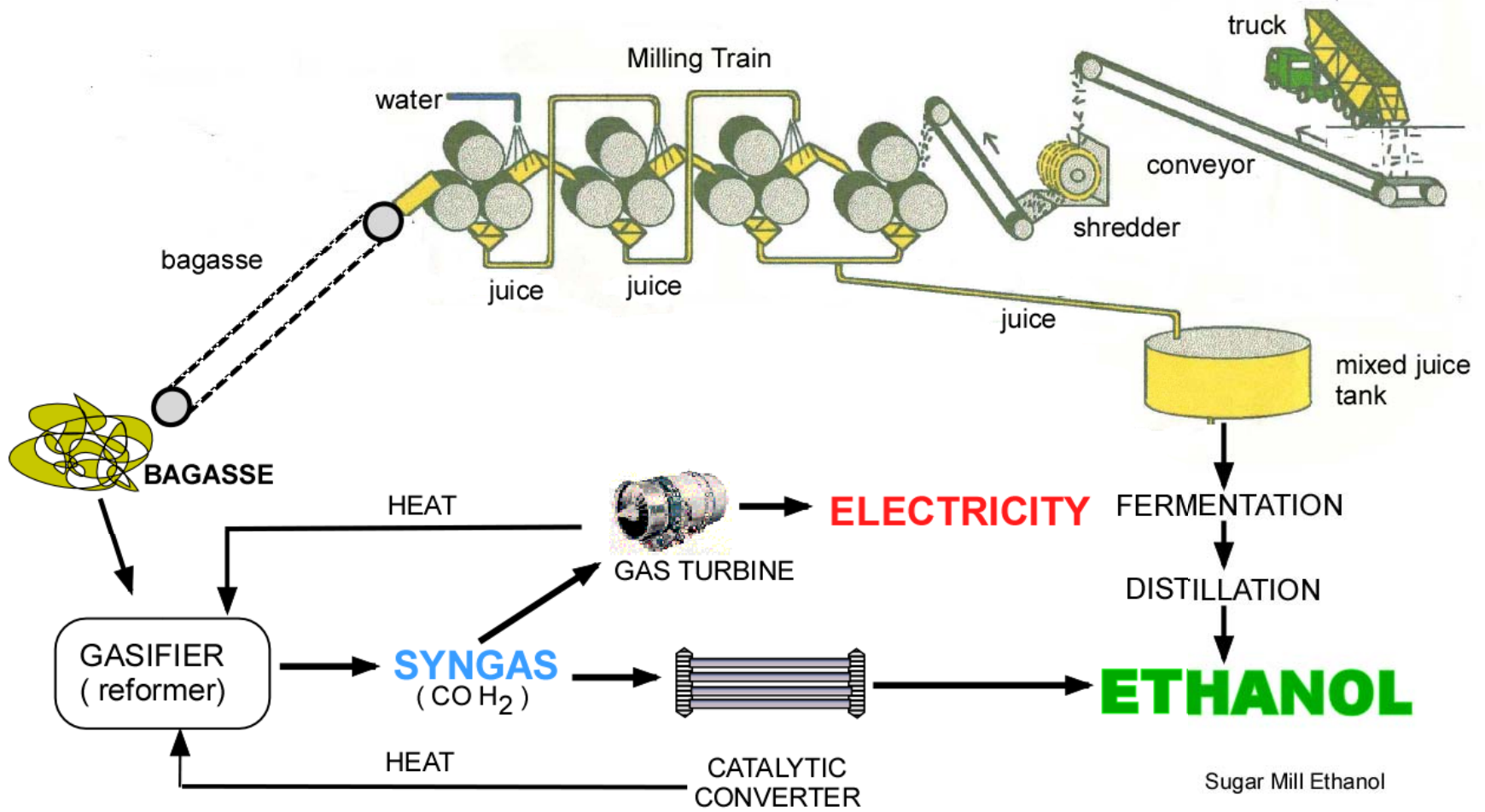

BIODIESEL



METHANOL from GLYCERINE

OIL > BIODIESEL > GLYCEROL > METHANOL

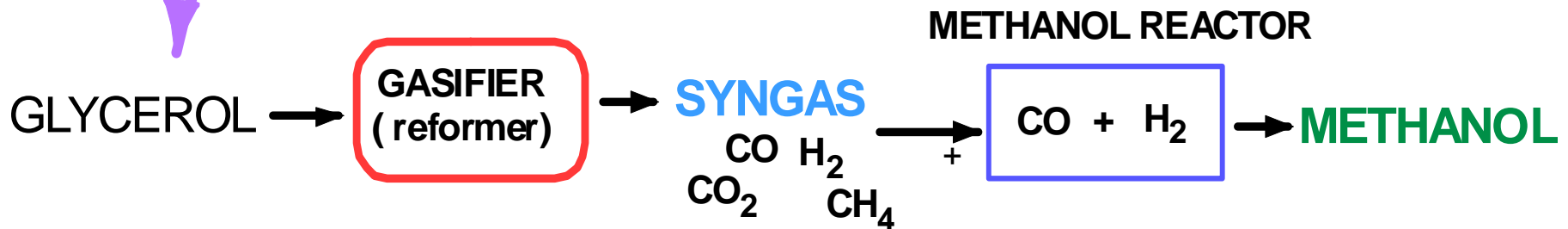
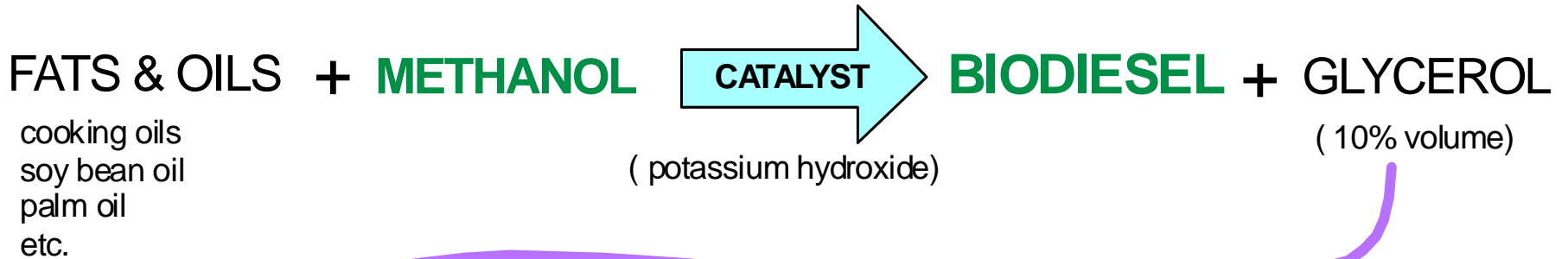

Hawaii Waste Opportunities

HAWAII MSW COMPOSITION

MSW - ENERGY/ ETHANOL POTENTIAL

Paper.....	24%
Food.....	8%
Wood Yard Green.....	32%
<hr/>	
TOTAL.....	64 %

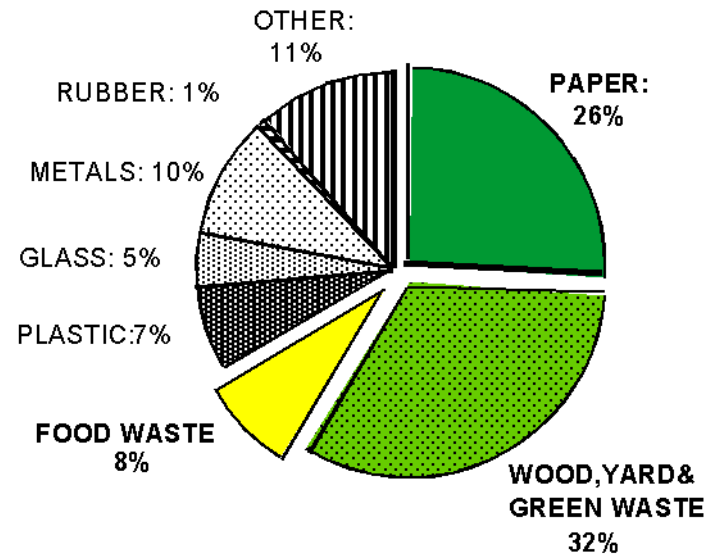

Oahu – Waste to Ethanol

ETHANOL from MSW		
(OAHU ANNUAL ETHANOL FROM MSW)		
Nov-04		
Oahu Population	900,000	
Oahu annual Waste (tons)	1,600,000	
Ethanol gallons / ton	110	
WASTE COMPONENT	Percent of total	Annual Amount (tons)
Paper	26.20%	419,200
Yard Waste	17.90%	286,400
Wood	12.00%	192,000
TOTAL	56.10%	897,600
Annual Ethanol (gal)	98,736,000	
Annual Gasoline Consumption (gal)	400,000,000	
Ethanol / Gasoline %	25%	

BIOMASS OPPORTUNITIES

- Biomass can be a big energy opportunity fo Hawaii !
- All hydrocarbon sources can be part of the equation
- We need an analysis of the available and potential resource base
- We need a financial analysis of the supply train for each technology
- Government and the private sector must make a commitment to developing these resources
- Hawaii can be a leader as a **center for biomass energy technology demonstration and transfer**

BIOMASS TECHNOLOGY

CONCLUSIONS

Everything is connected

**Waste can be one of our
“Most Sustainable Resources”**

Wasting Waste is Wasteful !



ClearFuels Technology Inc.

THANK YOU

Contact Information

Robert Shleser Ph.D. / CTO
ClearFuels Technology Inc.; Suite 308
Hawaii Agricultural Research Center
99-193 Aiea Heights Drive
Aiea, HI 96701

rshleser@clearfuels.com

Phone 808 259-5042

Enabling Highly Efficient Low Cost Sustainable Energy Production